

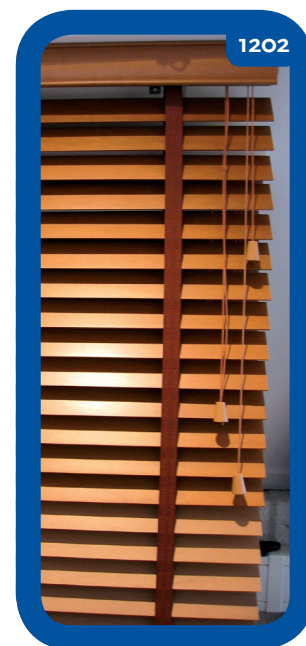

Store en bois lames de 50 mm solide d'une très haute qualité. Le caisson de 57 x 51 mm permet d'installer ce store sur des fenêtres plus larges que ne permettent pas des caissons classiques. Tous les accessoires sont de même couleur que les lames en bois.



Options

Orientation	1100	Droite
	1101	Gauche
	1103	Monter/descendre - Droite Orientation lames - Gauche
	1104	Monter/descendre - Gauche Orientation lames - Droite

Mécanisme	1202	Corde et cordelette
------------------	------	---------------------

Fixations	1300	De face
	1304	Latérales

Autres	1904	Câble de guidage
	1910	Câbles de guidage pour lame finale complète
	1907	Cache caisson
	1908	Bandelettes 25 mm
	1909	Bandelettes 38 mm
	1942	Couleurs lames multiples
1946	Caisson en aluminium	

Informations

Lames	Bois peint de haute qualité (Ramin)
Largeur	50 mm
Caisson	Acier thermolaqué 57.8 x 51.5 x 0.5 mm
Lame finale	Bois peint 51 x 16 mm
Cordelette	Polyester 2.5 mm
Cordon	Polyester largeur 5.3 mm
	Distance entre échelles 44 mm
Bandelette 1	Polyester largeur 53 x 44 x 25 mm (option)
Bandelette 2	Polyester largeur 53 x 44 x 38 mm (option)

Divers

Longueur cordelette	Standard 2/3 de la hauteur du store Egalement sur mesure
----------------------------	---

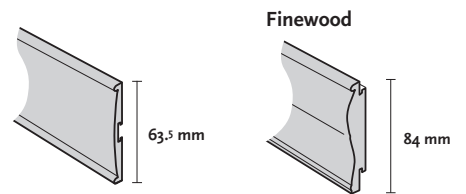
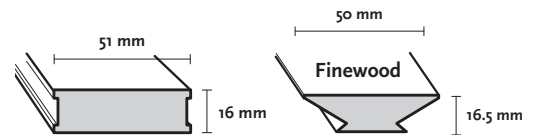
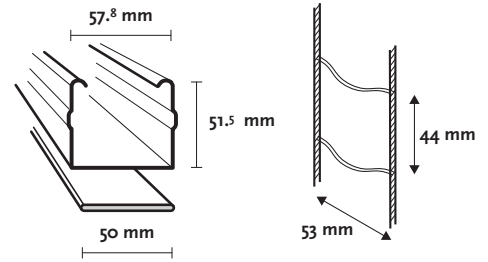
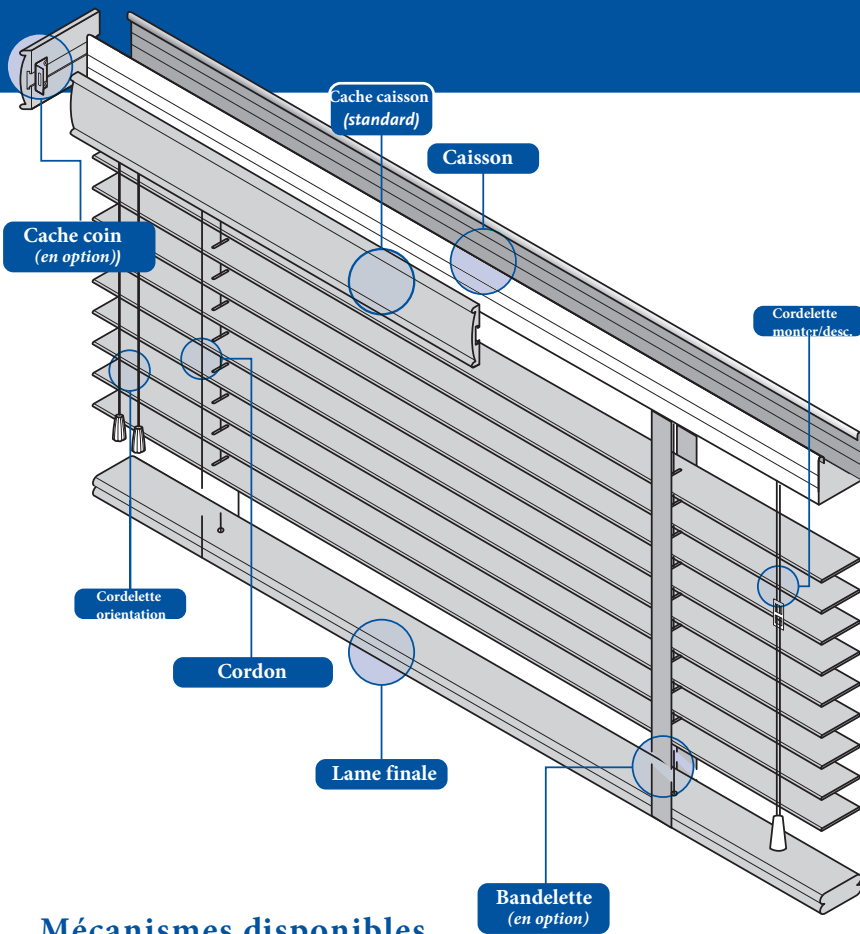

Mécanismes disponibles

Dimensions disponibles

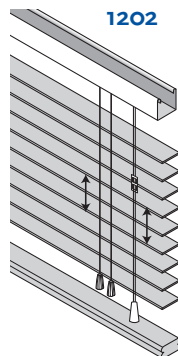

Option	cm			
	larg.	haut.	m2	
1202	Max.	240-300*	300	5
	Min.	45	40	0,18

* Dépend du bois

Fixations

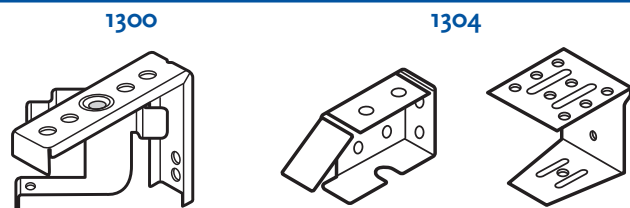

Hauteur store fermé

Haut. (A)	mm	
	LC	LB
500	110	125
1000	130	165
1500	170	205
2000	200	245
2500	230	285
3000	260	325

LC = cordelette
LB = bandelette

Autres

